

# ROCK

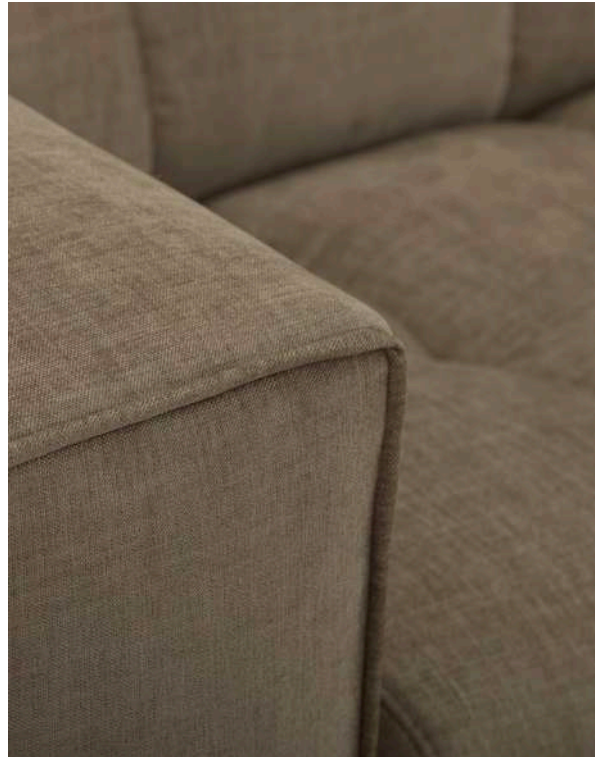

# VILMERS

# ROCK



## Comfort

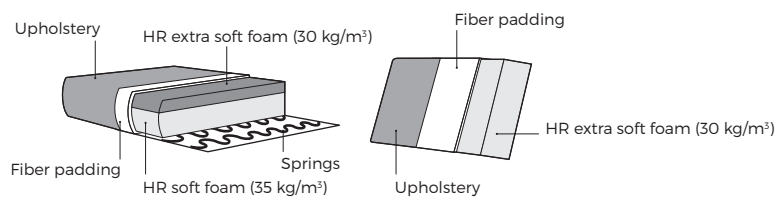

## 1. Upholstery



Leather\*

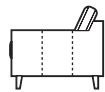

Fabric

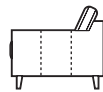

\* Leather and fabric upholstery contain the same number of stitches.

## 2. Legs



345  
Black  
Metal

### IMPORTANT:

Upholstered furniture is handmade using soft materials, therefore measurements can vary in all modules by up to **+/-2 cm**.  
Modules and combinations shown in 2D drawings are left-sided. Modules and combinations can be mirrored from left to right.

## Modules

Scale 1:100

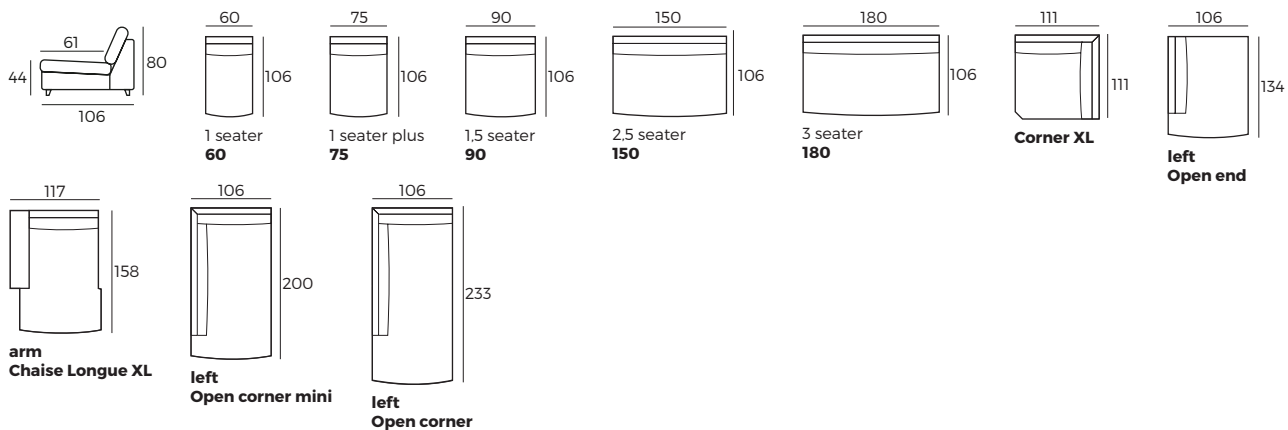

# ROCK

## Modules with armrest

Scale 1:100

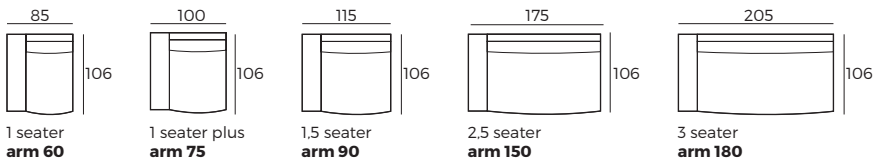

## Combinations

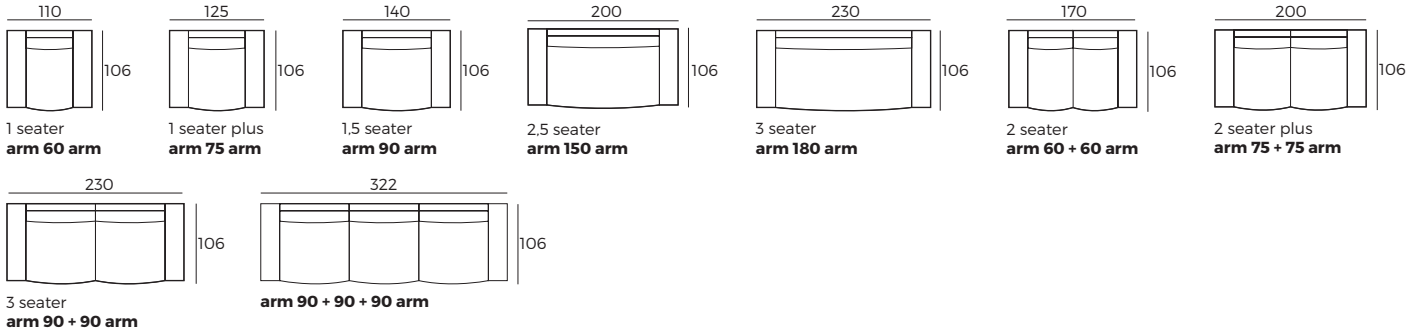

## Accessories

