

JOANA



VILMERS

JOANA



Comfort

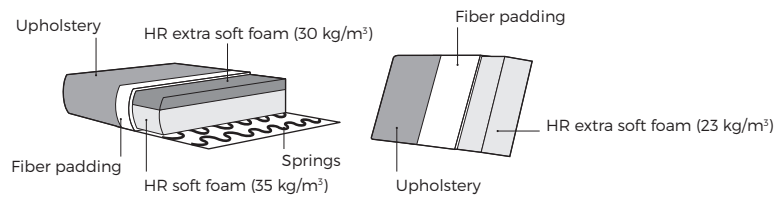

1. Upholstery

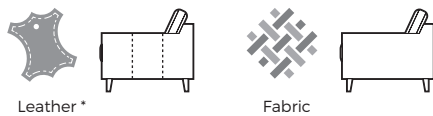

* Leather upholstery may require more stitches than fabric upholstery.

2. Headrest & seat type

* Measurements for fully opened mechanism.

- 1 Manual ↷
- 2 Electrical ⚡

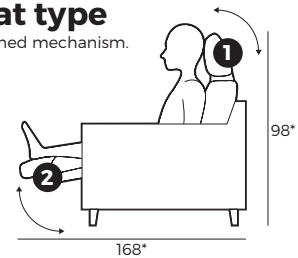

3. Armrest



A Fully closed
W 11 x D 98 x H 66

A Fully opened
W 23 x D 98 x H 51

B Fully closed
W 11 x D 98 x H 66

B Fully opened
W 23 x D 98 x H 51

4. Legs



IMPORTANT:

Upholstered furniture is handmade using soft materials, therefore measurements can vary in all modules by up to **+/-2cm**.
Modules and combinations shown in 2D drawings are left-sided. Modules and combinations can be mirrored from left to right.

Modules (Measurements with fully opened armrest)

Scale 1:100

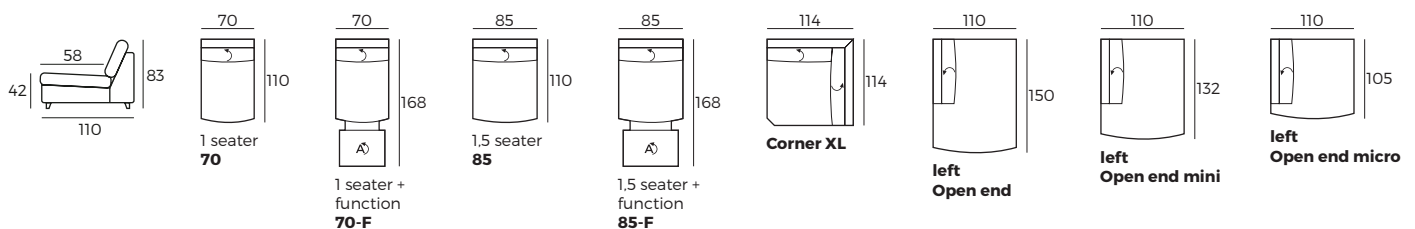

JOANA

Modules (Measurements with fully opened armrest)

Scale 1:100

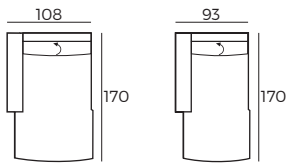

arm
Chaise Longue

arm
Chaise Longue mini

Modules with armrest (Measurements with fully opened armrest)

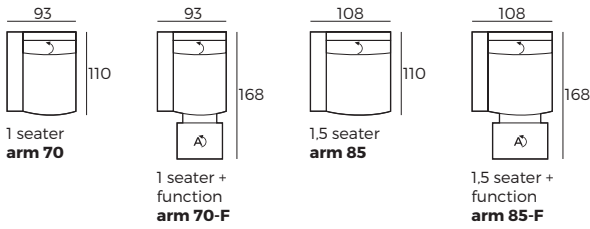

Combinations (Measurements with fully opened armrest)

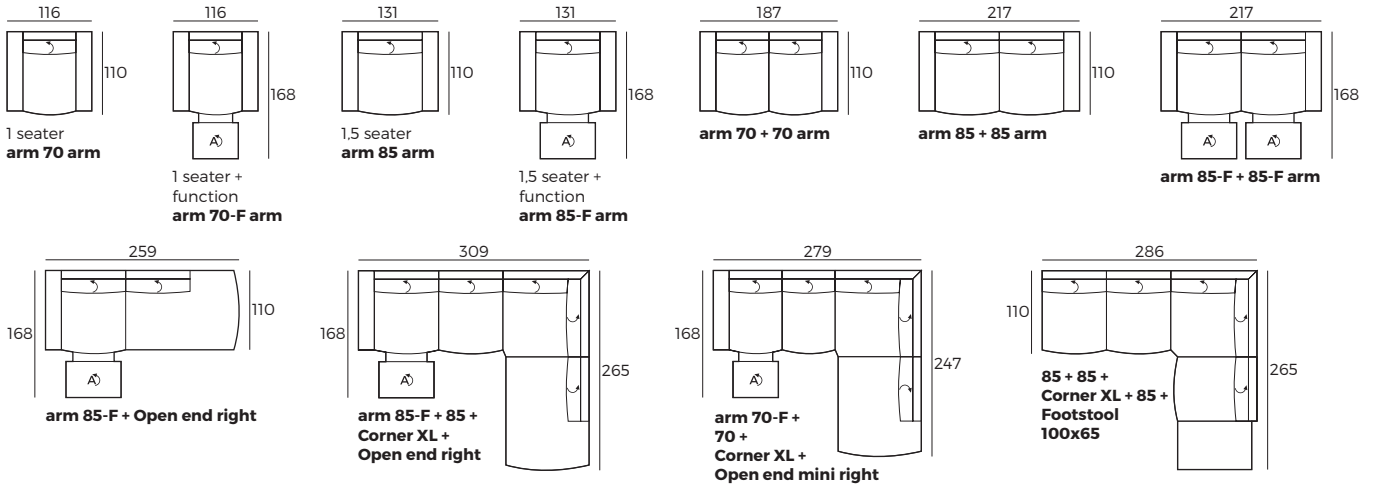

Accessories

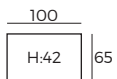

Footstool
100x65

↶ - manual; ⚡ - electrical *F - single electric function