

CAROLINA



VILMERS

CAROLINA



Comfort

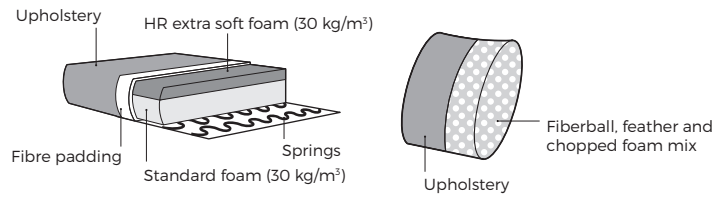

1. Upholstery

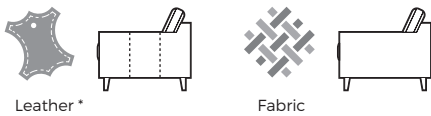

* Leather upholstery may require more stitches than fabric upholstery.

2. Armrests

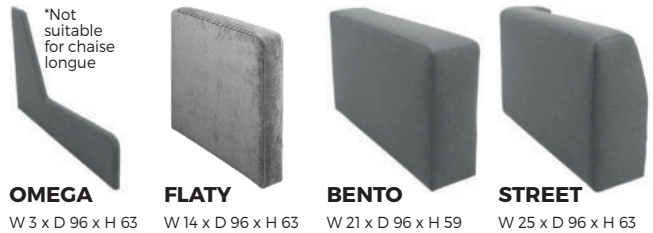

3. Choose cushions

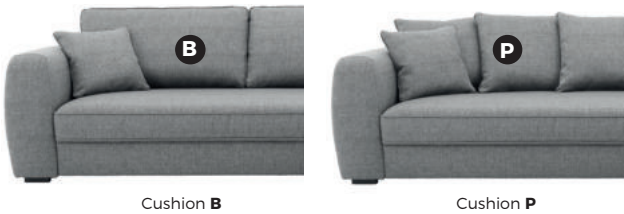

4. Legs



IMPORTANT:

Upholstered furniture is handmade using soft materials, therefore measurements can vary in all modules by up to **+/-2 cm**.
Modules and combinations shown in 2D drawings are left-sided. Modules and combinations can be mirrored from left to right.

Modules (Measurements with STREET armrest)

Scale 1:100

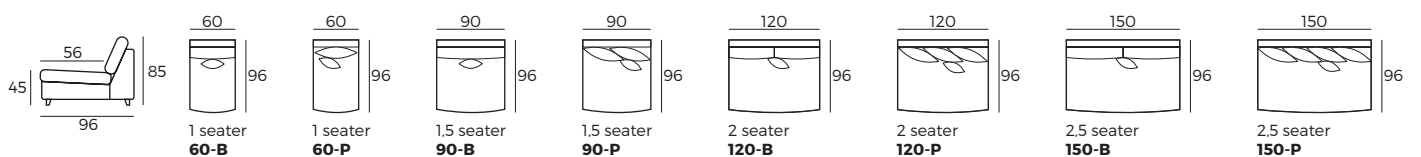

CAROLINA

Modules (Measurements with STREET armrest)

Scale 1:100

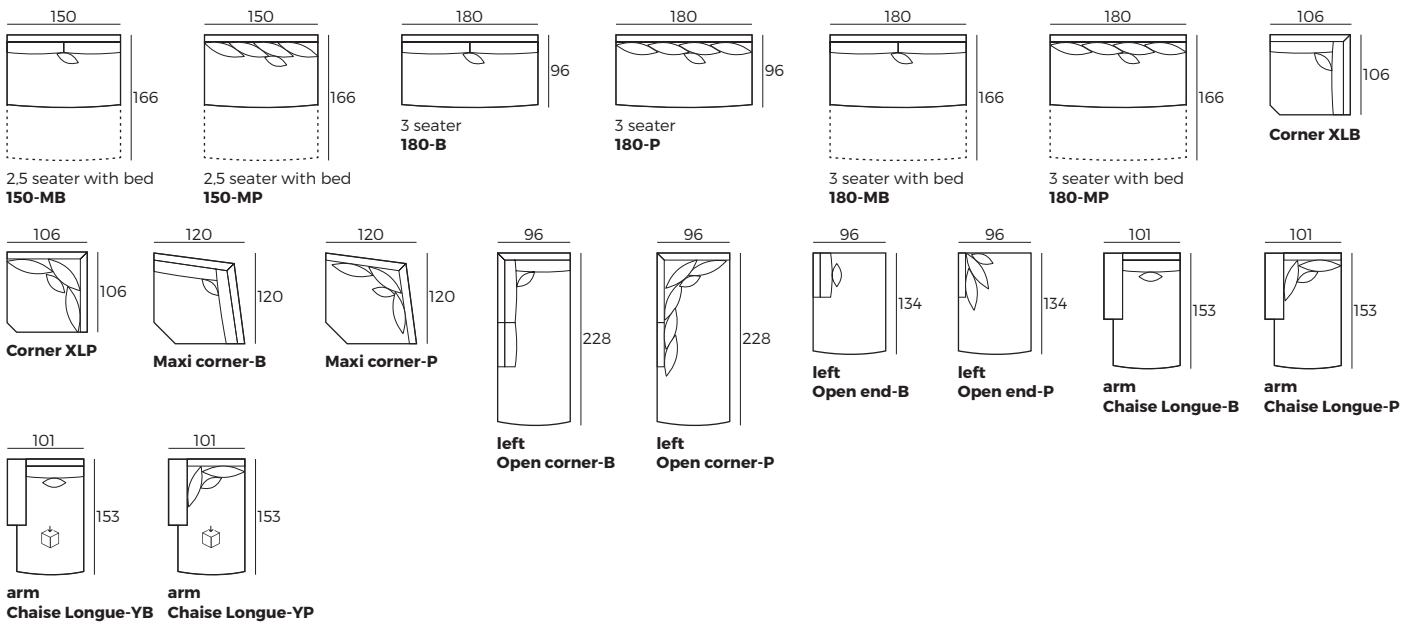

Modules with armrest (Measurements with STREET armrest)

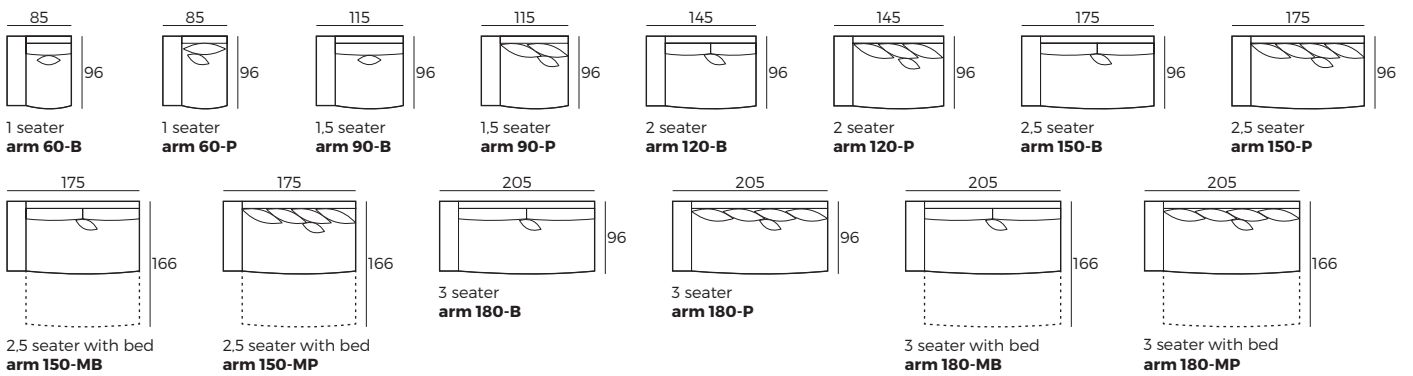

Combinations (Measurements with STREET armrest)

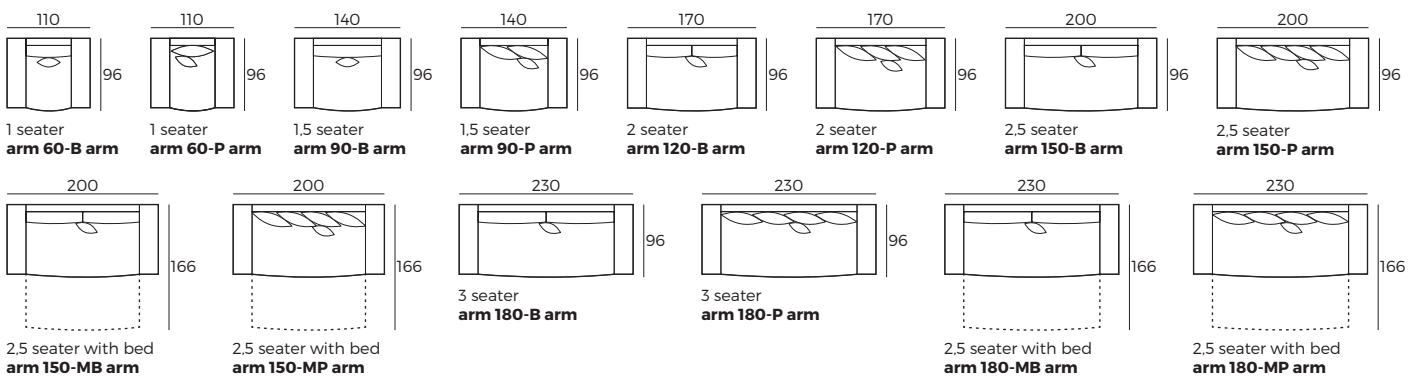

Accessories

