

ALPS



VILMERS

ALPS



Comfort

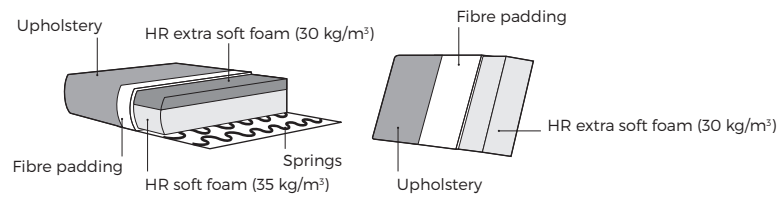

1. Upholstery

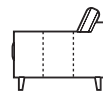
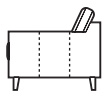

* Leather and fabric upholstery contain the same number of stitches.

2. Legs



IMPORTANT:

Upholstered furniture is handmade using soft materials, therefore measurements can vary in all modules by up to **+/-2cm**.
Modules and combinations shown in 2D drawings are left-sided. Modules and combinations can be mirrored from left to right.

Modules

Scale 1:100

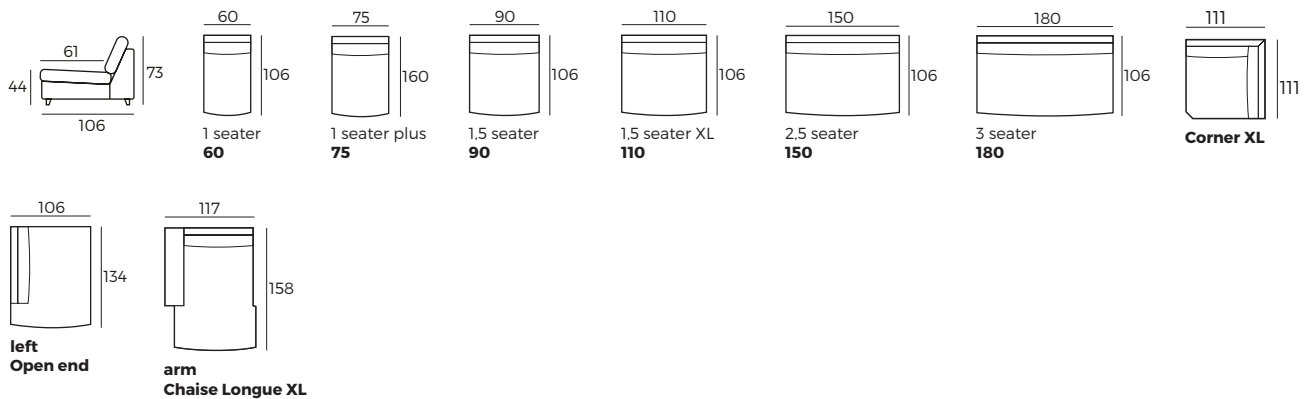

ALPS

Modules with armrest

Scale 1:100

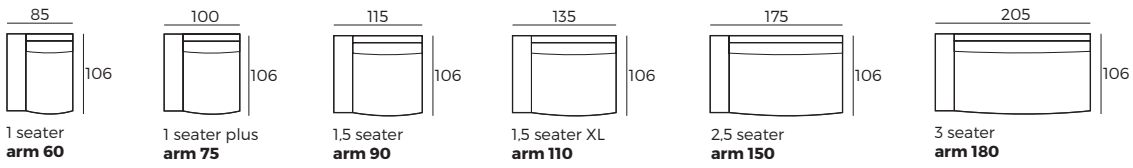

Combinations

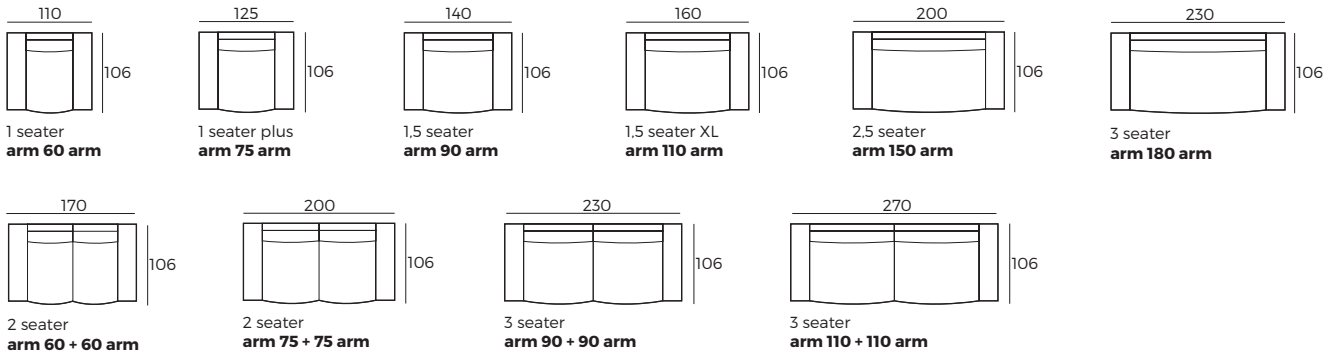

Accessories

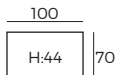

Footstool
100x70