

Nordic



VILMERS

Nordic



Comfort

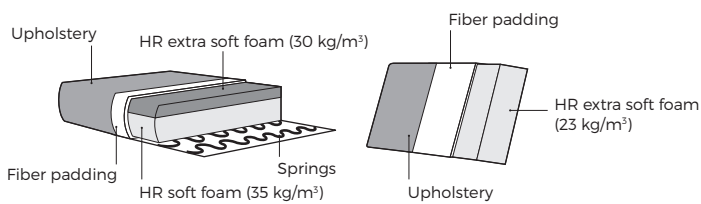

1. Upholstery

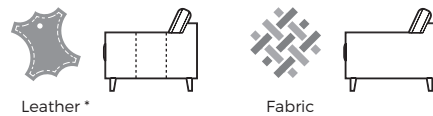

* Leather covers may require more stitches than fabric covers.

2. Armrests

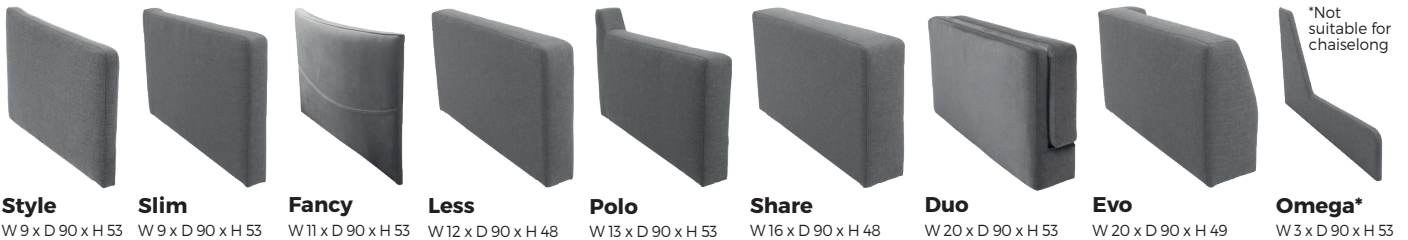

3. Legs



IMPORTANT:

Upholstered furniture is handmade using soft materials, therefore measurements can vary in all modules by up to +/- 2 cm.

Parts and sets shown in 2D drawings are left-sided. Parts and sets can be mirrored from left to right.

For an additional fee, the sides of each individual part can be covered in fabric.

Modules (Measurements with Share armrest)

Scale 1:100

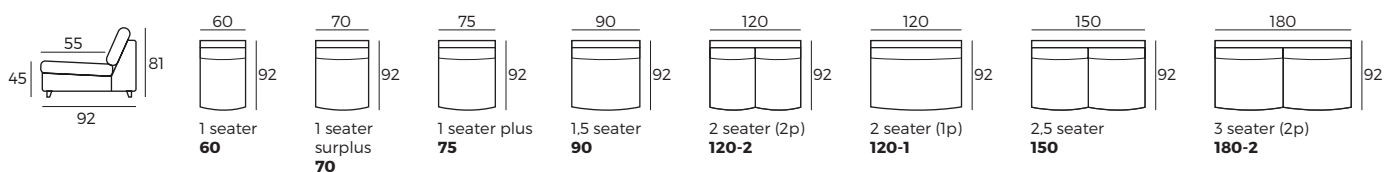

Nordic

Modules (Measurements with Share armrest)

Scale 1:100

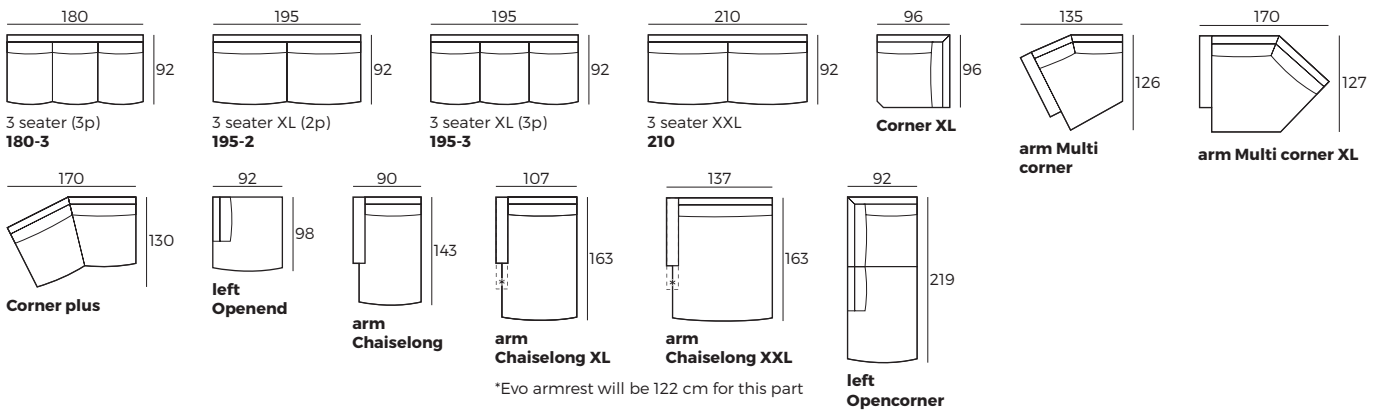

Modules with armrest (Measurements with Share armrest)

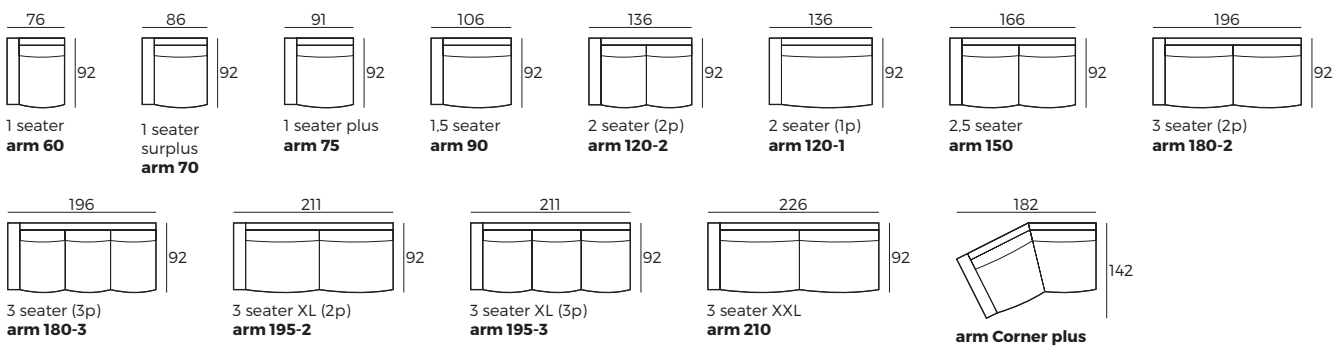

Combinations (Measurements with Share armrest)

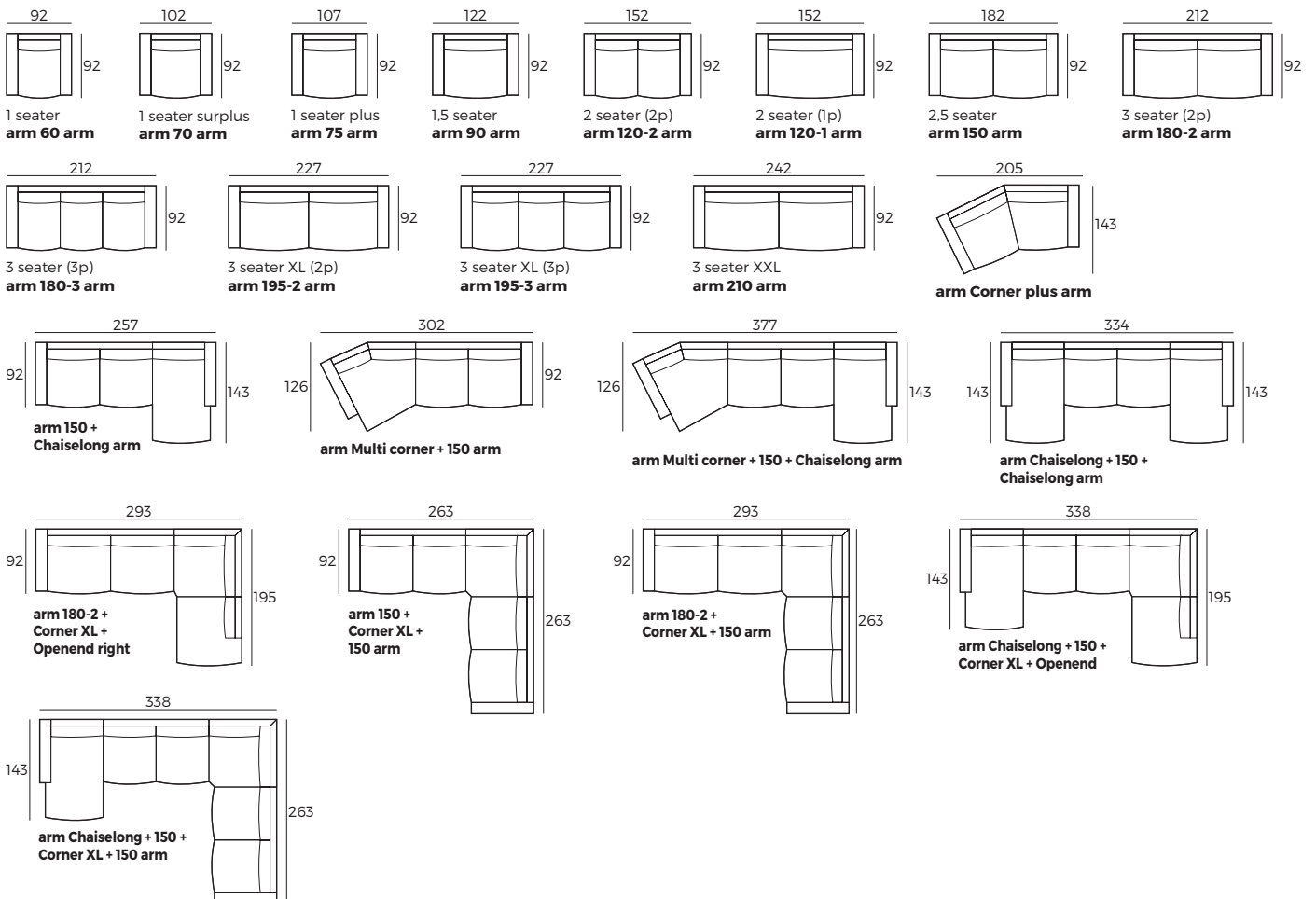

Nordic

Combinations (Measurements with Share armrest)

Scale 1:100

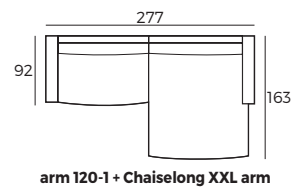
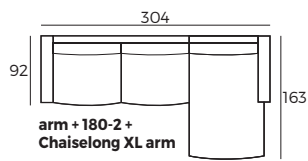
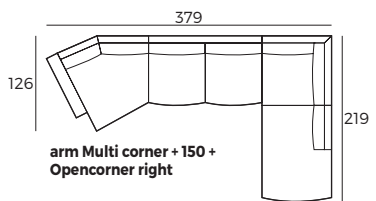
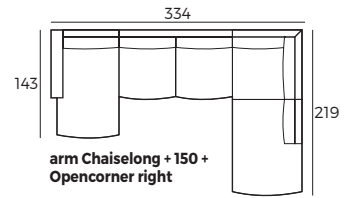
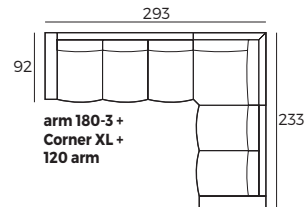
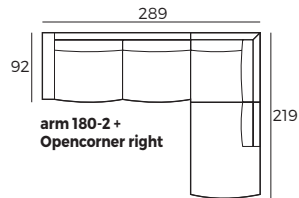
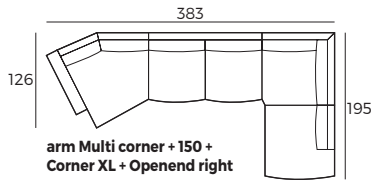
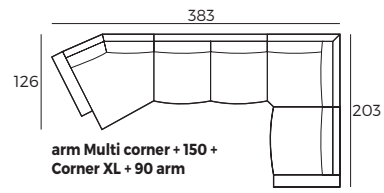
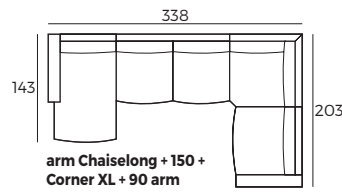
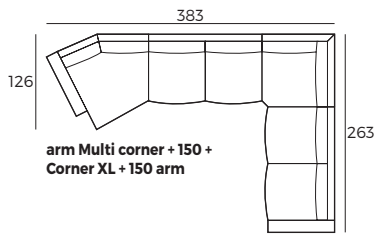

Accessories

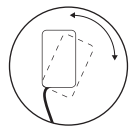
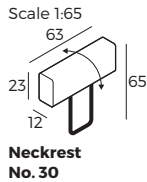
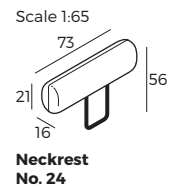
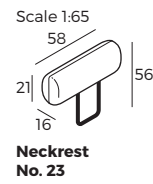
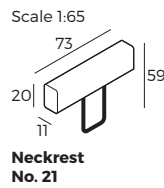
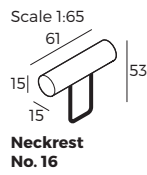
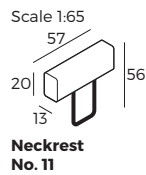
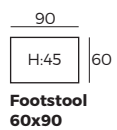
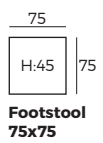

With click-clack
function