

# More



## VILMERS

# More



## Comfort

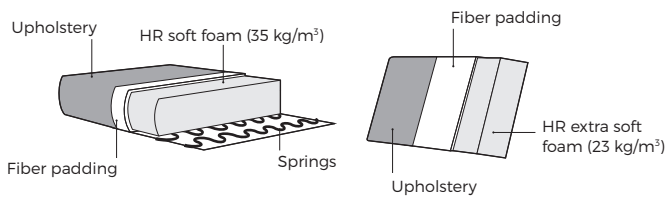

## 1. Upholstery

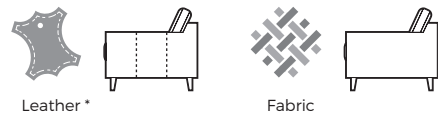

\* Leather covers may require more stitches than fabric covers.

## 2. Armrests



## 3. Legs



\* The height of all legs can be either 6 cm or 8 cm.

### IMPORTANT:

Upholstered furniture is handmade using soft materials, therefore measurements can vary in all modules by up to **+/-2 cm**.

Parts and sets shown in 2D drawings are left-sided. Parts and sets can be mirrored from left to right.

For an additional fee, the sides of each individual part can be covered in fabric.

## Modules (Measurements with Grande armrest)

Scale 1:100

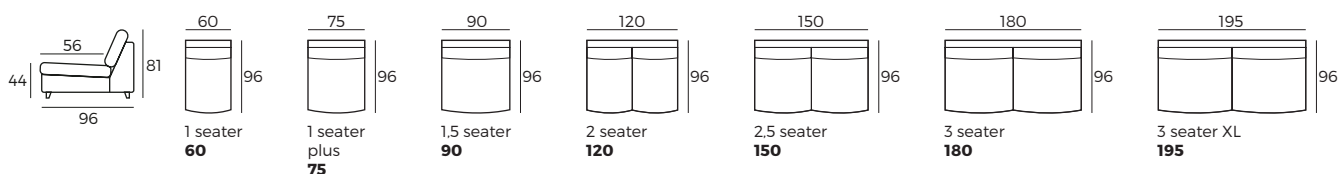

# More

## Modules (Measurements with Grande armrest)

Scale 1:100

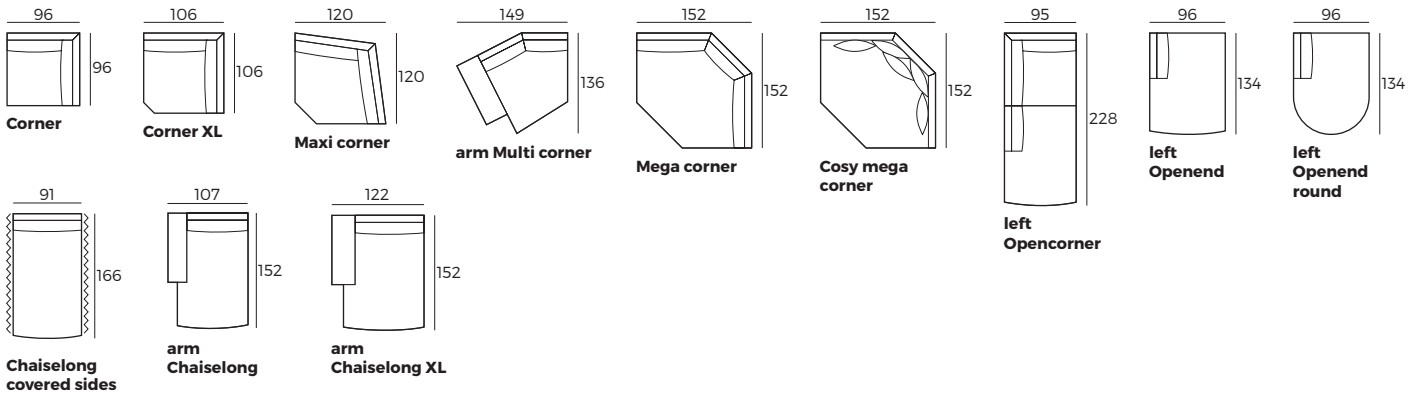

## Modules with armrest (Measurements with Grande armrest)

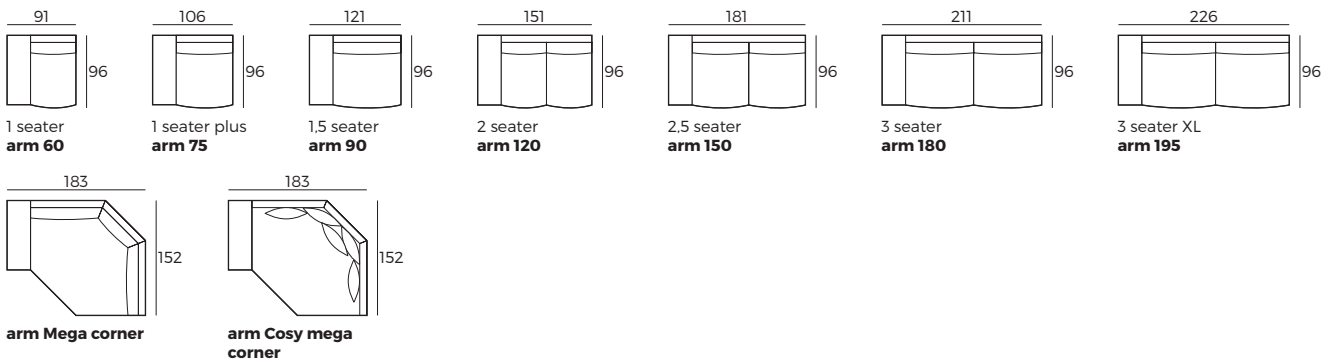

## Combinations (Measurements with Grande armrest)

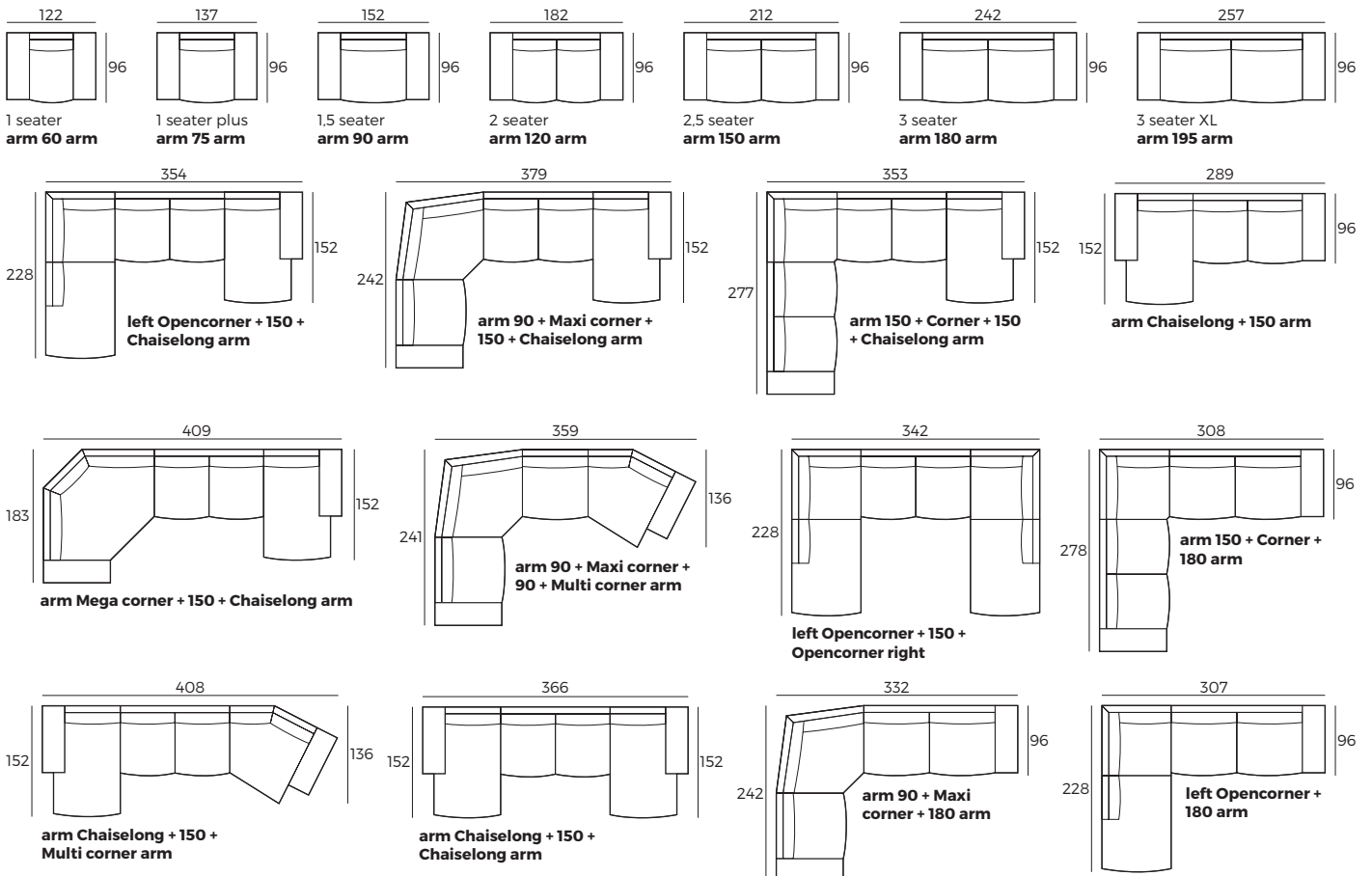

# More

## Combinations (Measurements with Grande armrest)

Scale 1:100

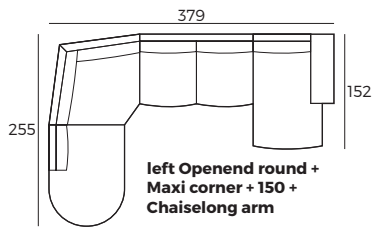

## Accessories

